

## Multichannel, multifunction Transmitter/Controller

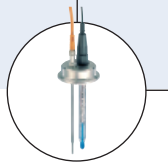

- Compatible with most common flow, pH/O.R.P. and conductivity sensors, directly connected
- Analogue and digital input signals
- Easy, intuitive user interface supported by a large adjustable backlit display (4 user defined views)
- Basic transmitter/controller with hardware extension (up to 6 free slots), selectable software extensions
- Data logging

Type 8619 can be combined with...



**Type 8200+8203**

pH/O.R.P. sensor

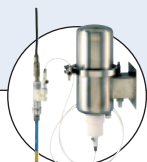

**Type 8201**

pH system

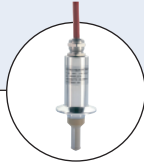

**Type 8221**

Conductivity sensors  
4-pole technology



**Type 8220**

Conductivity sensors  
2-pole technology



**Type 8030**

INLINE  
flowmeter

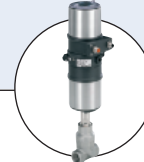

**Type 8802**

Process control  
valve

The 8619 multichannel multifunction is a transmitter/controller for connection of sensors which deliver raw signals for pH, O.R.P. and conductivity and flow via pulses or sensors which delivers analogue signals: 0... 20 mA, 4... 20 mA, 0 - 5 V, 0 - 10 V.

Type 8619 is the ideal device for measurement and control and as well dosing processes e.g. in applications of water treatment plants (like boiler, cooling tower or reverse osmosis systems) and food and pharma plants.

Modularity in hardware and software offer high flexibility for adjusting it to the applications resulting in having a very good price to functionality relation.

Sophisticated electronics and state of the art control algorithms ensure that optimum process control is maintained at all times with minimal operator intervention and achieving highest quality.

Technical data	
<b>General data</b>	
<b>Mounting</b>	panel mount unit for 92 x 92 mm cutout
<b>Materials</b>	Housing*, fastening element / Seal PPO / Silicone Cover, vision panel / Overlay PC / Silicone rubber Backplate / Screws Stainless steel 304 / Stainless steel 316 Plug-in connector / Pin PBT / Copper alloy gold-plated
<b>Display</b>	LC graphic display, light blue backlighted; 128 x 168 pixels resolution; German, English, French languages
<b>Keypad</b>	4 soft keys [F1] [F2] [F3] [F4] for dynamic functions 1 central navigation key with [↑] [↓] [→] [←] assignments
<b>Data logger</b>	up to 16 values
<b>Sensor monitor</b>	Direct display and verification of measured sensor values
<b>Clock</b>	Real-time clock with date
<b>Module slots</b>	6
<b>Electrical connection</b>	Plug-in connectors
<b>Recommended cable</b>	Shielded cable Solid H05(07) V-U 0.2 to 1.5 mm <sup>2</sup> Flexible H05(07) V-K 0.2 to 1.5 mm <sup>2</sup> With wire end ferrule 0.2 to 1.5 mm <sup>2</sup> With plastic collar ferrule 0.2 to 1.5 mm <sup>2</sup>

\* on request: plastic and stainless steel wall mount enclosure

Technical data - Mainboard	
<b>Electrical data</b>	
<b>Operating voltage</b> ("SUPPLY")	12 - 36 V DC, filtered and regulated
<b>Power consumption</b> (of multiCELL device - without additional modules and outputs not connected)	Max. 1.5 VA
<b>Power charges</b> ("PWR OUT")	12 - 36 V DC, max 1.8 A
<b>Digital inputs</b> <b>DI1, DI2</b>	Voltage: 0 - 36 V DC, input impedance 3 k $\Omega$ Switching threshold : $V_{on} = 5 - 36$ V DC, $V_{off} < 2$ V DC; Frequency: 0.5 to 2500 Hz Galvanic insulation, protected against reversed polarity of DC and voltage spikes
<b>Digital outputs</b> <b>DO1, DO2</b>	Transistor: can be wired as PNP or NPN, galvanic insulation, protected against short circuit, max. 36 V DC, max. 700 mA if only one transistor output is used, 1 A max. in total if both transistor outputs are used; Operating modes: On/Off, Hysteresis, Window, PWM, PFM, Pulse; Frequency: max. 2000 Hz
<b>Analogue output</b> <b>AO1, AO2</b>	4... 20 mA, can be wired as sourcing or sinking, galvanic insulation, protected against reversed polarity of DC, max. loop impedance: 1100 $\Omega$ at 36 V DC, 610 $\Omega$ at 24 V DC, 100 $\Omega$ at 12 V DC
<b>Memory card</b>	
Type	SD (Secure Digital) or SDHC (Secure Digital High Capacity)
Capacity	max. 8 GB

## Materials view

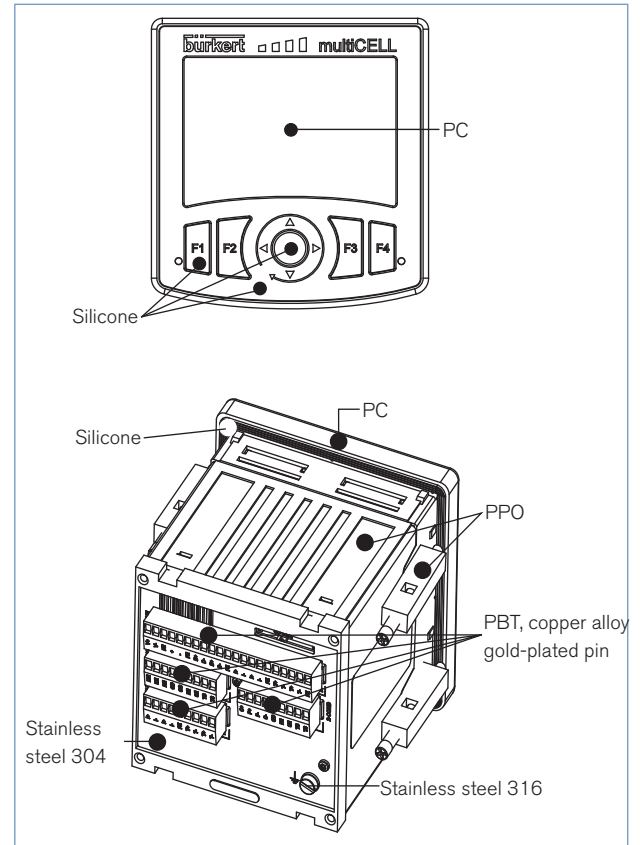

## Additional modules

4 different types of modules are available and can be inserted into any of the 6 slots (preconfigured at the factory)



- input module: 2 analogue inputs (4... 20 mA or 0... 20 mA or 0 - 5 V or 0 - 10 V) and 2 digital inputs (static or frequency/puls).
- output module: 2 transistor outputs and 2 analogue 4... 20 mA outputs
- input pH/ORP and Pt100/Pt1000 modules
- input conductivity and Pt100/Pt1000 modules

Technical data - input module	
<b>Power consumption</b>	0.1 VA
<b>Analogue inputs</b> <b>AI1, AI2</b>	can be wired as sourcing or sinking, galvanic insulation
Current	range: 0/3.5 - 22 mA max. voltage: 36 V DC impedance: 50 $\Omega$ resolution: 1.5 $\mu$ A
Voltage	range: 0 - 5/10 V DC max. voltage: 36 V DC impedance: 110 k $\Omega$ resolution: 1 mV
Error	$\pm 0,25\%$ of measured value
<b>Digital inputs</b> <b>DI1, DI2</b>	Voltage: 0 - 36 V DC, input impedance 3 k $\Omega$ Switching threshold : $V_{on} = 5 - 36$ V DC, $V_{off} < 2$ V DC; Frequency: 0.5 to 2500 Hz Galvanic insulation, protected against reversed polarity of DC and voltage spikes

Technical data - output module	
<b>Power consumption</b>	Max. 0.1 VA
<b>Digital outputs</b> <b>DO1, DO2</b>	Transistor: can be wired as PNP or NPN, galvanic insulation, protected against short circuit, max. 36 V DC, max. 700 mA if only one transistor output is used, 1 A max. in total if both transistor outputs are used; Operating modes: On/Off, Hysteresis, Window, PWM, PFM; Frequency: max. 2000 Hz
<b>Analogue output</b> <b>AO1, AO2</b>	4... 20 mA, can be wired as sourcing or sinking, galvanic insulation, protected against reversed polarity of DC, max. loop impedance: 1100 $\Omega$ at 36 V DC, 610 $\Omega$ at 24 V DC, 100 $\Omega$ at 12 V DC

Technical data - pH/ORP module	
<b>Power consumption</b>	0.1 VA
<b>pH/ORP input</b>	simultaneous pH and ORP measurement with input for electrochemical pH/ORP
<b>Temperature input</b>	Pt100/Pt1000, 2 or 3 wires
<b>pH measurement</b>	
Measuring range	-2.0... 16 pH or -600... +600 mV
Resolution	0.01 pH or 0.1 mV
Accuracy	±0.02 pH or 1 mV
<b>ORP measurement</b>	
Measuring range	-2000... +2000 mV
Resolution	0.1 mV
Accuracy	±1 mV
<b>Temperature measurement</b>	
Measuring range	-25°C to +130°C (-20°F to 266°F)
Resolution	0.1°C (0.18°F)
Accuracy	±1°C (1.8°F)

Technical data - conductivity module	
<b>Power consumption</b>	0.25 VA
<b>Conductivity input</b>	Operation with 2- or 4-pole-technology sensors
<b>Temperature input</b>	Pt100/Pt1000, 2 or 3 wires
<b>Conductivity/Resistivity measurement</b>	
Conductivity	
Measuring range	0 µS/cm... 2 S/cm (function of the conductivity cell)
Resolution	1 nS/cm
Error (without sensor)	< 0.5% of measured value
Resistivity	
Measuring range	0.5 Ω.cm... 100 MΩ.cm (function of the conductivity cell) - 5.0 Ω... 1 MΩ (conductivity module alone)
Resolution	0.1 Ω.cm
Error (without sensor)	< 0.5% of measured value
<b>Temperature measurement</b>	
Measuring range	-40°C to +200°C (-40°F to 392°F)
Resolution	0.1°C (0.18°F)
Accuracy	±1°C (1.8°F)

Environment conditions and standards - Mainboard, pH/ORP, conductivity, input and output modules	
<b>Ambient temperature</b>	
Operation	
Only Mainboard	-10°C to +70°C (14°F to 158°F) - limited to 0°C to +70°C (32°F to 158°F) if memory card is used
Min. 1 additional module	-10°C to +60°C (14°F to 140°F) - limited to 0°C to +60°C (32°F to 140°F) if memory card is used
Storage	-20°C to +70°C (-4°F to 140°F)
<b>Relative humidity</b>	< 85%, without condensation
<b>Height above sea level</b>	max. 2000 m
<b>Protection class</b>	IP65 (panel-mounted, cabinet closed) IP20 (panel-mounted, inside the cabinet) NEMA 4X (panel-mounted, in front of the closed cabinet)
<b>Standard and directives</b> 	
EMC	EN 61000-6-2, EN 61000-6-3
Vibration / Shock	EN 60068-2-6 / EN 60068-2-27
<b>Approvals</b>	
UL-Recognized for US and Canada 	61010-1 + CAN/CSA-C22 No.61010-1

**Dimensions [mm]**

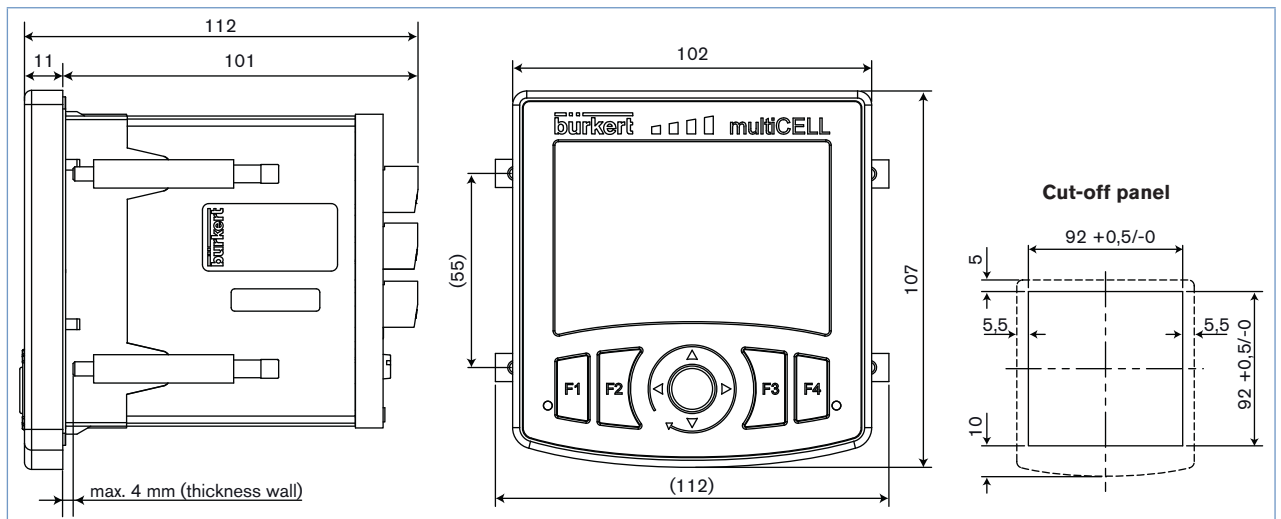

## Principle of operation

The transmitter/controller is given by the internal module based structure capable to handle different types of sensors and selectively execute operations on the measurement values. From simple measurement and standard signal output and assignment of integrated mathematical formulas for selectable values up to control and dosing tasks all that can run in parallel.

The modules for signals and functions can be easily connected to each other by configuration and with setting individual parameters all the functionality can be adapted to the actual process conditions. A 12 - 36 V DC power supply is sufficient to have the device running.

The base unit is a panel mount version and handles analogue and digital signal outputs, digital inputs and the front is supplied by a backlit graphical display. Up to six slots are available, which depending on the applications, can be occupied with modules for pH/O.R.P., conductivity, a module with additional analogue and digital outputs as well as a module with analogue and additional digital inputs. There is no need for a separate 4... 20 mA transmitter: the pH, conductivity modules accept raw signals from sensors.

Though highly functional the multiCELL can be operated easily and intuitively. The base for this is the large graphical display and the dynamically assigned function keys. Clearly arranged menu and module structures allow easy configuration and setting of parameters and offer a high transparency for the functions in use. Four user views can be configured by the operator. This allows the user to design a view himself displaying a value arrangement which he likes to see simultaneously and this can be available 4 times and independent from each other.

For data collection and storage e.g. of measurement values there is an optional data logger available which uses the memory card if inserted in the card slot. Uploading and restoring the complete database including the application special parameter settings of the complete 8619 and updating firmware via the memory card is available as standard.

## Construction

**The mainboard enables:**

- connection to the transmitter/controller power supply
- to power another device
- to dispose of 2 digital inputs (DI), 2 analogue (AO) and 2 digital (DO) outputs

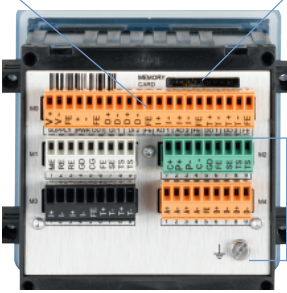

**Memory card slot :**

- For upload and download of parameter settings
- Software updates

Simple operation: insert the memory card into the small slot on the rear of the device.

**Additional module slots (up to 6) to choose among:**

- module for 2 analogue and 2 digital inputs (small orange connector)
- module for 2 analogue and 2 digital outputs (black connector)
- module for pH/O.R.P. sensor and/or temperature sensor (light grey connector)
- module for conductivity sensor and/or temperature sensor (green connector)

## Display and dynamic soft keys

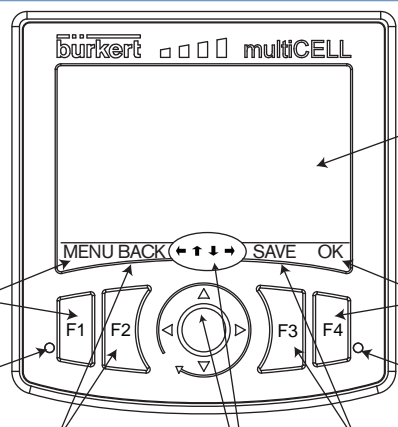

To activate the first dynamic function on the very left side, press F1

LED

To activate the second dynamic function, press F2

Light blue backlit LC graphic display

MENU BACK (← ↑ ↓ →) SAVE OK

To activate the dynamic function on the very right side, press F4

LED

To activate the third dynamic function, press F3

The navigation keys allows to move the cursor in vertical and horizontal directions  
The pointer above the navigation key indicates the directions which are usable related to the current display

## Process diagram

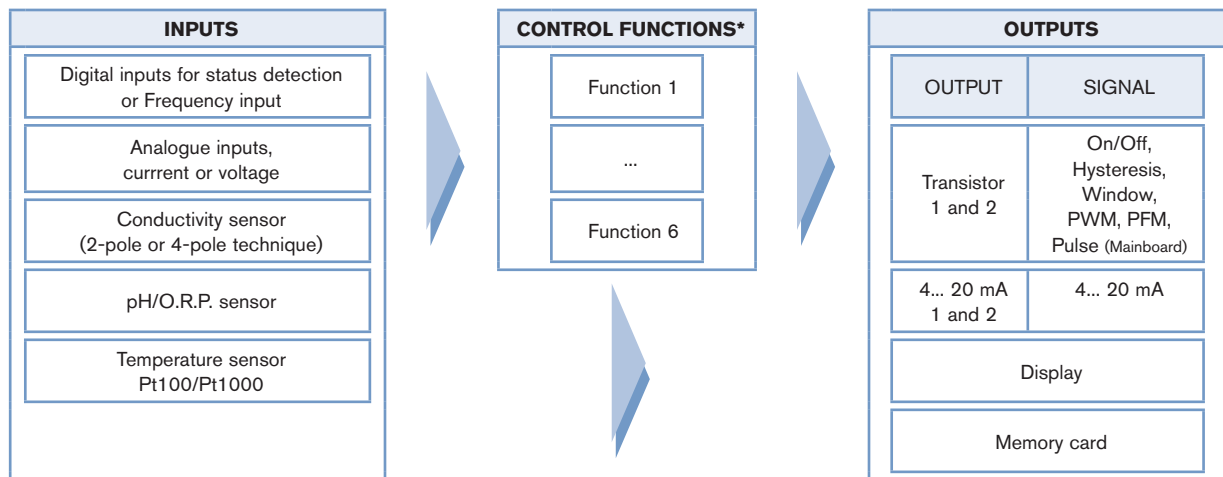

\* simultaneously and independently operating

## List of available functions







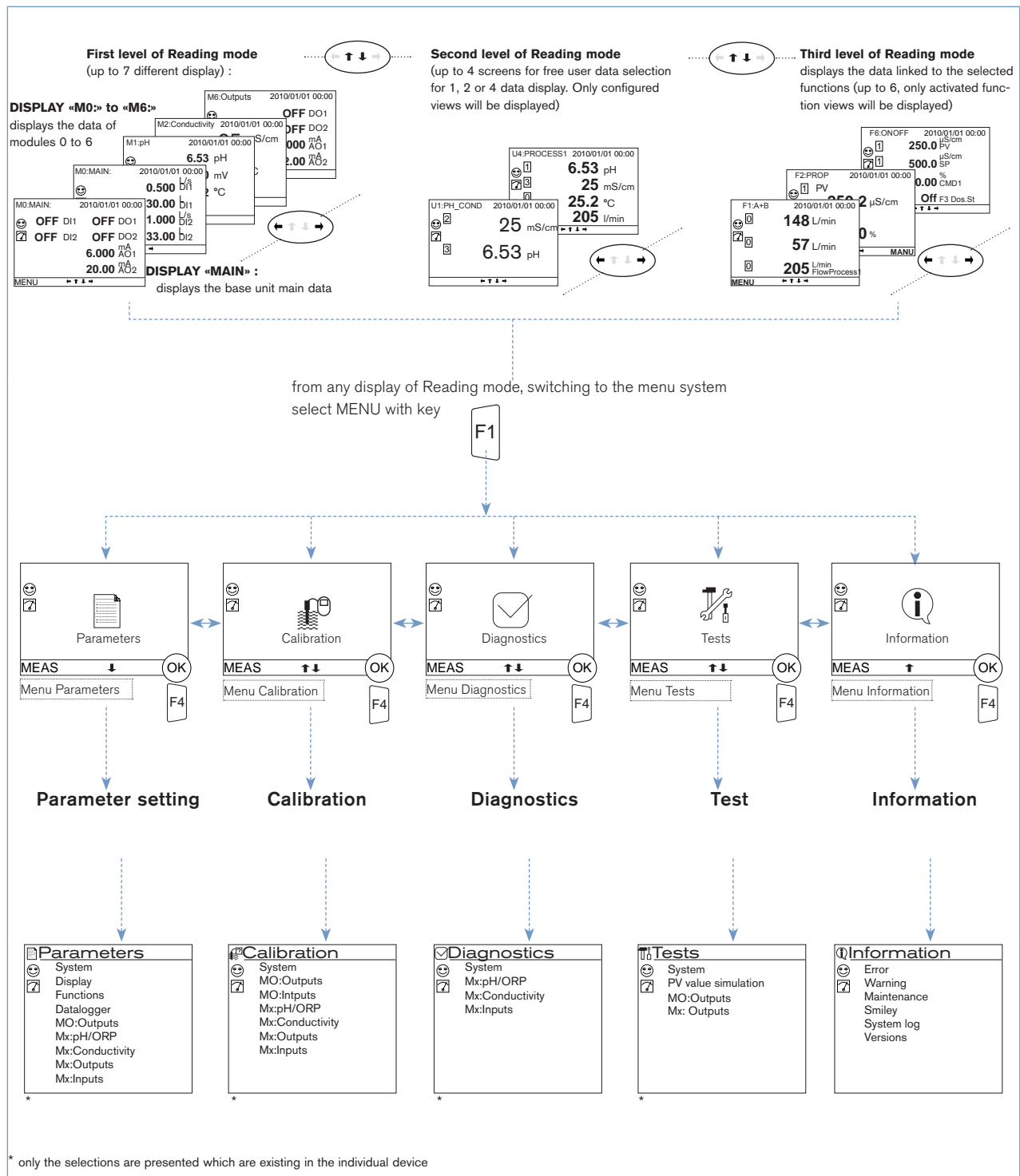

The transmitter/controller allows to allocate each sensor signal to a function (such as dosage, for example) fully configurable by the user. According to the model the following functions are offered as standard or as option

Functions	Availability	Formula	Example for usage
<b>Arithmetic</b>	Basic for all models	<b>A+B, A-B, A/B</b>	arithmetic operation between 2 values with same units. A or B can be a result of another function
<b>PASS</b>	Basic for all models	$\frac{A}{B} \times 100\%$	calculates a flow ratio between 2 values. e.g: reverse osmosis
<b>REJECT</b>	Basic for all models	$(1 - \frac{A}{B}) \times 100\%$	calculates a reject ratio between 2 values. e.g: reverse osmosis
<b>DEVIAT</b>	Basic for all models	$(\frac{A}{B} - 1) \times 100\%$	calculates a deviation ratio between 2 values.
<b>PROP</b>	Basic for all models		calculates an output in proportion to a scaled input
<b>ON/OFF</b>	Basic for all models	<b>On/Off control loop</b>	for any type of input
<b>Flow rate measurement</b>	As base for model item no. 560205, 560213, for others as option		allows both digital inputs to be used as frequency inputs for flow measurement (in standard for base unit) or coexistent with analytical modules (in option for others devices)
<b>PID</b>	As option	<b>Continuous control loop</b>	for any type of input and with internal or external setpoint
<b>Time dosing</b>	As option		e.g. for cooling tower application. Dosing of 1 or 2 biocides in the circuits, at fixed time intervals or by defining dosing during one week, with 2 dosings per day. Can be connected to an ON/OFF conductivity function for prebleed.
<b>Special Chemical batch (Volume dosing)</b>	As option		specifically for cooling tower application. A defined volume of water is counted, then an actuator is energized during a defined time to add a chemical and the water volume being counted is resetted.
<b>Concentration</b>	As option		the concentration curves of NaCl, H <sub>2</sub> SO <sub>4</sub> , HNO <sub>3</sub> , NaOH, HCl are implemented for use in complete concentration range and not only in low concentration.
<b>Data logging on memory card</b>	As option		up to 16 values can be stored at a defined time interval.

Menu structure



Ordering chart for multiCELL transmitter/controller Type 8619

Description	Operating voltage	Inputs				Outputs		UL Approvals	Item no.
		Digital (DI) (On/Off or frequency)	Analogue (AI) 0/4... 20 mA	number and type of sensor raw signals	Pt100/ Pt1000	Transistor (DO) (PWM or PFM or On/Off or pulse)	Analogue (AO) 4... 20 mA		
BASE unit with flow measurement (Mainboard)	12-36 V DC	2	-	-	-	2	2	No	560 205
								 UL-Recognized	560 213
pH/ORP (Mainboard + 1 pH/ORP module)	12-36 V DC	2	-	1 (pH/ORP)	1	2	2	No	560 200
								 UL-Recognized	560 208
pH/ORP (Mainboard + 2 pH/ORP modules + 1 output module)	12-36 V DC	2	-	2 (pH/ORP)	2	4	4	No	560 202
								 UL-Recognized	560 210
CONDUCTIVITY (Mainboard + 1 conductivity module)	12-36 V DC	2	-	1 (Cond.)	1	2	2	No	560 201
								 UL-Recognized	560 209
CONDUCTIVITY (Mainboard + 2 conductivity modules + 1 output module)	12-36 V DC	2	-	2 (Cond.)	2	4	4	No	560 203
								 UL-Recognized	560 211
pH/ORP and CONDUCTIVITY (Mainboard + 1 pH/ORP module + 1 conductivity module + 1 output module)	12-36 V DC	2	-	1 (pH/ORP) + 1 (Cond.)	2	4	4	No	560 204
								 UL-Recognized	560 212
INPUT (Mainboard + 1 input module)	12-36 V DC	4	2	-	-	2	2	No	563 960
								 UL-Recognized	563 961
pH/ORP + INPUT (Mainboard + 1 pH/ORP module + 1 input module + 1 output module)	12-36 V DC	4	2	1 (pH/ORP)	1	4	4	No	563 962
								 UL-Recognized	563 963
CONDUCTIVITY + INPUT (Mainboard + 1 conductivity module + 1 input module + 1 output module)	12-36 V DC	4	2	1 (Cond.)	1	4	4	No	563 964
								 UL-Recognized	563 912

Notes regarding the ordering of above mentioned multiCELL transmitter/controller:

- The above items are equipped of arithmetic, PASS, REJECT, DEVIAT, PROP, ON/OFF functions in standard (see p. 9, List of available functions). In the BASE unit the Flow measurement function is also a standard function, the other functions are available as option. Please also use the "request for quotation" form on page 9 [go to page](#) for ordering a device with additional options.
- If a totalizer function is required then a Flowmeter has to be connected via a digital input (mainboard or input board)

Ordering chart for additional software functions for Type 8619

Use the following order codes only in case you already own a 8619 and you like to add one or more of the given functions to your device.



Please don't forget to note down the Item no. and serial number (see the device label) of your multiCELL on your order.

Software option	Remark	Item no.
PID control	-	561 836
Data Logger	SD card is not included.	561 837
Chemical dosing (e.g. cooling tower)	The "Dosing" option also activates the "Flow" option if it does not exist by default in the device.	561 838
Flow measurement	Already be contained in the base unit device (560 205 and 560 213)	561 839
Concentration measurement of selected fluids	Requires at least one conductivity hardware board	561 840

Remark: the function upload and download of the complete data set of the 8619 is available as standard and does not need the data logger option

Ordering chart for accessories for Type 8619

Description	Item no.
SDHC Memory Card - Class 10 - 8 GB	564 072

Examples for interconnection possibilities with other Bürkert devices

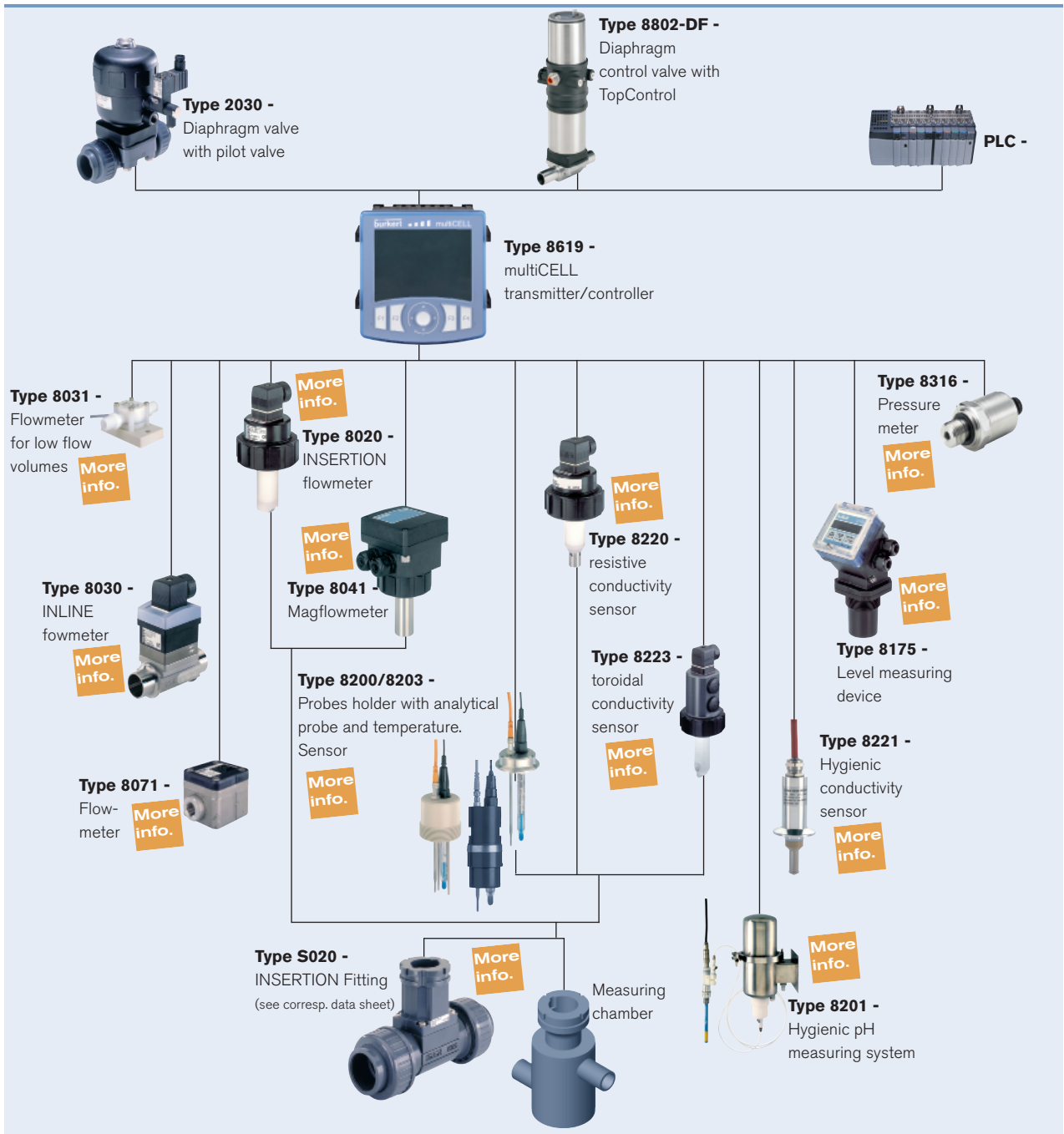

When you click on the orange box "More info." below, you will come to our website for the resp. product where you can download the data sheet.



You will find more info about sensor-multiCELL connection cable in the data sheet of the selected sensor type. Please consult the corresponding data sheet.



**multiCELL Transmitter/controller Type 8619 - request for quotation**

**Note**  
You can fill out the fields directly in the PDF file before printing out the form.

Please fill in and send to your local Bürkert Sales Centre\* with your inquiry or order.

Company:	Contact person:
Customer No.:	Department:
Address:	Tel. / Fax.:
Postcode / Town:	E-mail:

**multiCELL Transmitter/controller 8619**

Quantity:       Desired delivery date:

■ **Hardware:**     Mainboard<sup>1)</sup> (without flow function; if needed please order the flow measurement software option)

<b>Slot M1</b>	<input type="checkbox"/> pH/ORP + temperature module	<input type="checkbox"/> conductivity + temperature module	<input type="checkbox"/> output module <sup>2)</sup>	<input type="checkbox"/> input module <sup>3)</sup>
<b>Slot M2</b>	<input type="checkbox"/> pH/ORP + temperature module	<input type="checkbox"/> conductivity + temperature module	<input type="checkbox"/> output module <sup>2)</sup>	<input type="checkbox"/> input module <sup>3)</sup>
<b>Slot M3</b>	<input type="checkbox"/> pH/ORP + temperature module	<input type="checkbox"/> conductivity + temperature module	<input type="checkbox"/> output module <sup>2)</sup>	<input type="checkbox"/> input module <sup>3)</sup>
<b>Slot M4</b>	<input type="checkbox"/> pH/ORP + temperature module	<input type="checkbox"/> conductivity + temperature module	<input type="checkbox"/> output module <sup>2)</sup>	<input type="checkbox"/> input module <sup>3)</sup>
<b>Slot M5</b>	<input type="checkbox"/> pH/ORP + temperature module	<input type="checkbox"/> conductivity + temperature module	<input type="checkbox"/> output module <sup>2)</sup>	<input type="checkbox"/> input module <sup>3)</sup>
<b>Slot M6</b>	<input type="checkbox"/> pH/ORP + temperature module	<input type="checkbox"/> conductivity + temperature module	<input type="checkbox"/> output module <sup>2)</sup>	<input type="checkbox"/> input module <sup>3)</sup>

■ **Software:**

- PID
- Data logger
- Chemical dosing (e.g. Cooling Tower) + special batch (The "Dosing" option also activates the "Flow" option if it does not exist by default in the device)
- Flow measurement
- Concentration Measurement for selected fluids (only if one of the slot is equipped with a conductivity module)

<sup>1)</sup> 2 digital inputs + 2 analogue outputs + 2 transistor outputs  
<sup>2)</sup> 2 analogue outputs + 2 transistor outputs  
<sup>3)</sup> 2 analogue inputs + 2 digital inputs

NOTE: If a totalizer function is required then a flowmeter has to be connected via a digital input (mainboard or input board)

DTS 1000130448 EN Version: I Status: RL (released | freigegeben | valide) printed: 29.08.2013

To find your nearest Bürkert office, click on the orange box →

[www.burkert.com](http://www.burkert.com)